



Crema viso al fiordaliso bio,
Crema d'Acqua di Laboratoires
Klorane (22,90 euro).

Candela 100% naturale
al mandarino, cannella e fava
tonka, Christmas Wish
di Neom (58 euro).



Decorazione
da parete
in cartone
riciclato,
Studio Roof
(14,95 euro).

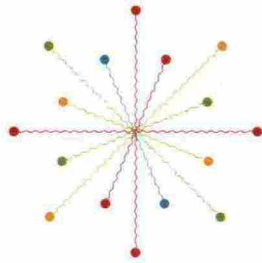

Piaceri
per
la mente

*Tanti libri, sport,
fragranze rilassanti
e passatempi
che nutrono l'anima*



Decorazione da parete
con cristalli e suoni
per bilanciare i chakra,
Ariana Ost (122,95 euro).



Profumatore
d'ambiente al miele,
Note di Natale
di Acqua dell'Elba
(42 euro).

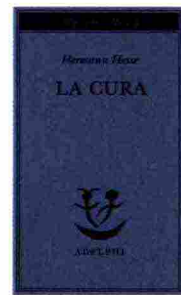

Una guida a vacanze
salutiste e raffinate,
Great Escapes Yoga.
The Retreat Book,
Taschen (40 euro).

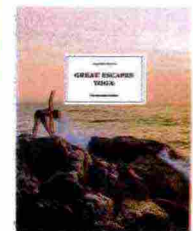

Un romanzo
introspeetivo
e di crescita, *La cura*
di Hermann Hesse,
Adelphi (12 euro).



Macchina fotografica
digitale con schermo
LCD inclinabile
in tre direzioni,
X-T5 di Fujifilm
(da 2.039,99 euro).

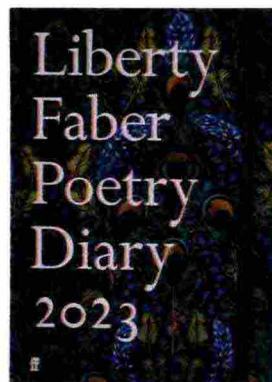

Agenda rivestita
con tessuti Liberty
Fabric, Liberty Faber
Poetry Diary 2023
di Faber & Faber
(17,20 euro).



E-reader
con possibilità
di scrittura, Kindle
Scribe di Amazon
(da 399,99 euro).

Diffusore di aromi
a ultrasuoni,
Sharp (49 euro).



Costume intero in lamé,
Oséree (200 euro).



Set giardinaggio con borsa
in cotone antimacchia,
Amazon.it (41,99 euro).



Profumatore eco
all'aroma
di resina
di foglie d'abete,
Pin Rouge
di Wally 1925
(24 euro).

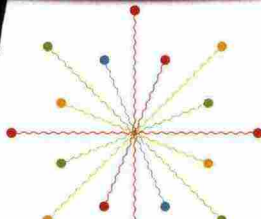

L'ABBONAMENTO
A NATURAL STYLE!

Per te, la tua famiglia, i tuoi amici,
una bussola per vivere green:
12 numeri di *Natural style*
a soli 18 euro. Scrivi a
abbonamenti@cairoeditore.it
o telefona allo 02.43313468.

Flip flop in raso
e gomma
naturale,
Carlotha Ray
(195 euro).



Stationary bike interattiva
in legno e cristallo,
Fuoripista di Adriano
Design per Elite.

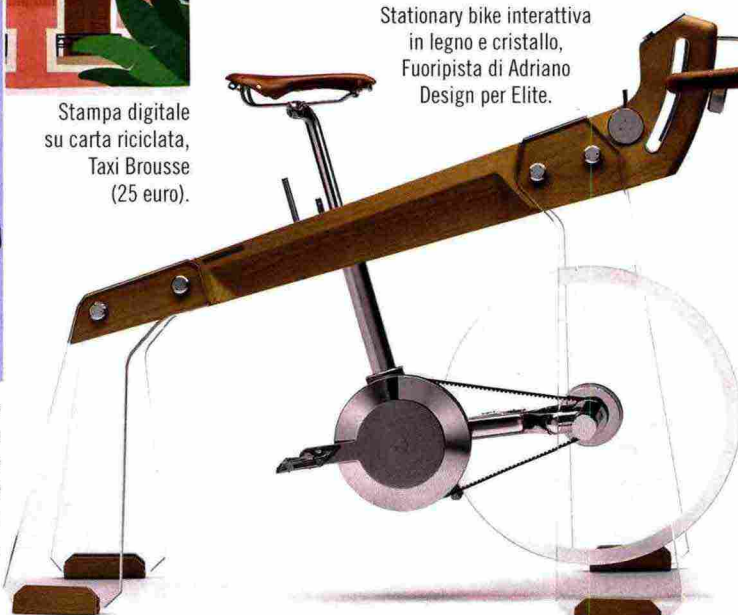

Stampa digitale
su carta riciclata,
Taxi Brousse
(25 euro).

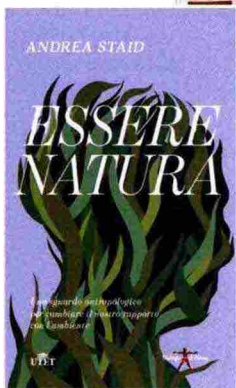

Manifesto ecologico, *Essere natura. Uno sguardo antropologico per cambiare il nostro rapporto con l'ambiente* di Andrea Staid, UTET (15 euro).



Profumatore d'ambiente
che armonizza il Doshia Pitta,
Soul Flow di Lakshmi
(66,15 euro).